

# ACOOL

ALPHACOO – THE COOLING COMPANY

## Alphacool Eisblock Aurora Acryl GPX-N RTX 3090 Founders Edition Incl. Backplate

EN





















ACCESSORIES

DE

ZUBEHÖR

FR

ACCESSOIRES

						
1x 8x74x1mm pad	1x 15x78x1mm pad	2x 15x51x1mm pads	1x 15x15x1mm pad	1x 15x38x1mm pad	1x 15x100x1mm pad	1x 8x84x1mm pad
						
4x 8x8x1mm pad	1x 30x30x2mm pad	2x 15x51x2mm pads	1x 15x15x2mm pad	1x 15x38x2mm pad	1x 8x74x3mm pad	1x 8x84x3mm pad
						
4x M2x5 screws	4x M2x5 washers	5x M2x11 screws	2x Screw plugs	1x Thermal grease	1x Plug tool	1x Digital – RGB adaptor

EN

Read the safety instructions before starting the installation. 

DE

Lesen Sie die Sicherheitshinweise, bevor Sie mit der Installation beginnen. 

FR

Lisez les instructions de sécurité avant de commencer l'installation. 



1.

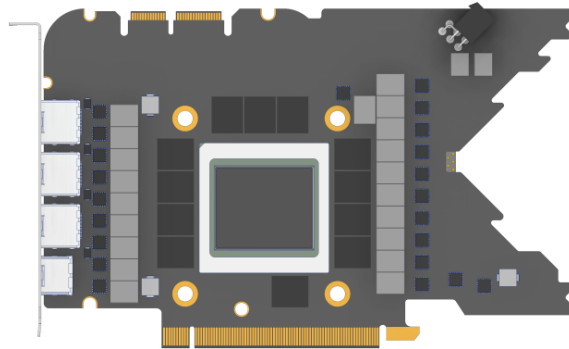

EN

Put the hardware on an antistatic mat. Begin dismantling the original cooler.

Depending on the structure of the cooler, remove the screws at the back of the card and carefully unhook the fan connector first. If the original cooler uses thermal glue, extreme care should be taken as you can easily damage parts. Pick up all the items carefully. Next, clean the hardware of thermal paste or pad residues with a solvent (e.g. isopropanol alcohol).

Before starting the cooler assembly, compare your card with the picture above. The cooler is constructed specifically for this layout. Occasionally, graphics card manufacturers may revise the design of their card slightly, causing the cooler not to fit on later models. During assembly, please make sure taller parts have enough space around them and that the cooler does not damage your graphics card.

**Alphacool International GmbH is not liable for assembly errors occurring due to negligence, such as selecting an incompatible cooler.**

DE

Legen Sie die Hardware auf eine antistatische Unterlage. Beginnen Sie mit der Demontage des Original-Kühlers. Je nach Aufbau des Kühlers sind zuerst die Schrauben des Lüfters zu entfernen und die Blenden zu lösen. Bei aufgeklebten Kühlern ist äußerste Sorgfalt geboten. Es können leicht Bauteile abgerissen werden. Heben Sie alle Einzelteile sorgfältig auf. Reinigen Sie anschließend die Hardware von Resten der Wärmeleitpaste oder Pads mit einem Lösemittel (z.B. Isopropanol-Alkohol).

Bevor Sie mit der Montage des Kühlers beginnen, vergleichen Sie Ihre Platine mit dem vorliegenden Foto. Der Kühler wurde speziell für dieses Layout konstruiert. Es kommt vor, dass Grafikkartenhersteller über Revisionen den Aufbau leicht abändern und damit der Kühler auf spätere Modelle nicht mehr passt. Achten Sie auch bei der Montage darauf, dass hohe Bauteile frei liegen und der Kühler die Grafikkarte nicht beschädigt.

**Alphacool International GmbH haftet nicht bei fahrlässigen Montagefehlern, wie die Wahl eines inkompatiblen Kühlers.**

FR

Posez le matériel sur un tapis antistatique. Commencez par le démontage du refroidisseur d'origine. Selon la configuration du radiateur les vis du ventilateur et les caches doivent être enlevés d'abord. S'il s'agit d'un refroidisseur collé il faut travailler très doucement. Sinon des composants peuvent s'arracher. Conservez tous les pièces soigneusement. Ensuite, nettoyez le matériel de résidus de la pâte thermique ou de pads avec un solvant (alcool isopropanol par ex.).

Avant de commencer l'installation merci de vérifier que votre carte ressemble bien à celle sur l'image. Le refroidisseur a été conçu spécialement pour cette disposition des composants. Il est possible que le fabricant change des détails dans la disposition de ses composants lors d'une révision et que le bloc de refroidissement ne soit plus compatible. Veuillez lors de l'installation au fait que les composants hauts ne touchent pas le bloc de refroidissement et que le bloc n'endommage pas la carte graphique.

**Alphacool International GmbH n'est pas responsable ni des erreurs d'installation ni du choix d'un refroidisseur incompatible.**

2.

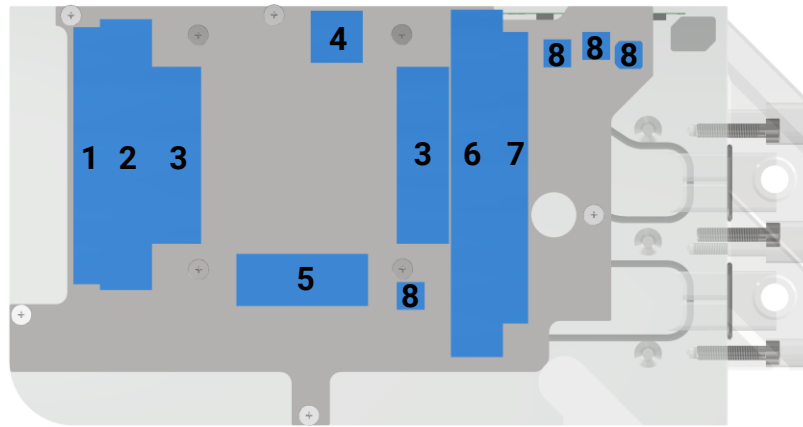

<p><b>EN</b> Clean the contact surfaces on the bottom side of the cooler with alcohol or similar. The surface must be free of contaminants. Remove the protective foils from the thermal pads and place the pads on the copper block as shown.</p>	<p><b>DE</b> Reinigen Sie die Kontaktflächen auf der Bodenseite des Kühlers mit Spiritus oder ähnlichen Mitteln. Die Fläche muss frei von Verunreinigungen sein. Entfernen Sie die Schutzfolien der Wärmeleitpads und platzieren Sie die Pads wie dargestellt auf dem Kupferblock.</p>	<p><b>FR</b> Nettoyez les surfaces de contact (la face inférieure du bloc de refroidissement) avec de l'alcool. La surface doit être propre sans aucune pollution. Retirez les feuilles de protection des pads thermiques et placez les pads sur le bloc de cuivre comme indiqué.</p>
--	--	---

3.

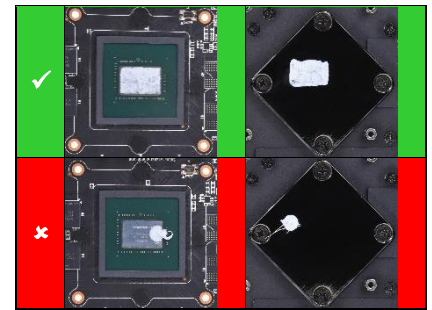
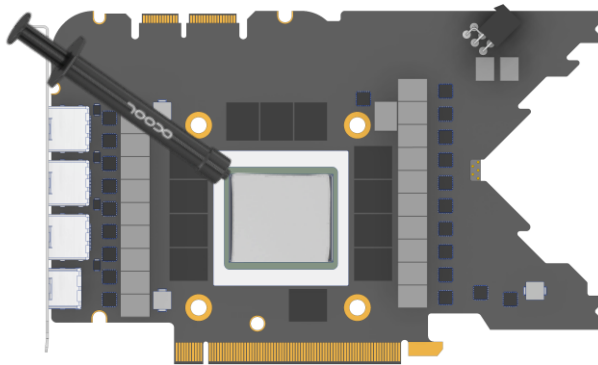

<p><b>EN</b> With the help of a plastic strip or similar spread a thin layer of thermal paste on the GPU. The layer should be less than a millimeter thick, otherwise the surrounding components may be contaminated unnecessarily.</p>	<p><b>DE</b> Tragen Sie nun eine gleichmäßige Schicht Wärmeleitpaste auf die GPU auf. Die Schicht sollte weniger als einen Millimeter dick sein, da die umliegenden Bauteile ansonsten verunreinigt werden können.</p>	<p><b>FR</b> Appliquez maintenant la pâte thermique sur le processeur graphique à refroidir. Etalez-la à l'aide d'une bande en plastique. Afin d'éviter de salir les composants autour la couche doit rester inférieure à un millimètre d'épaisseur.</p>
---	--	--

4.

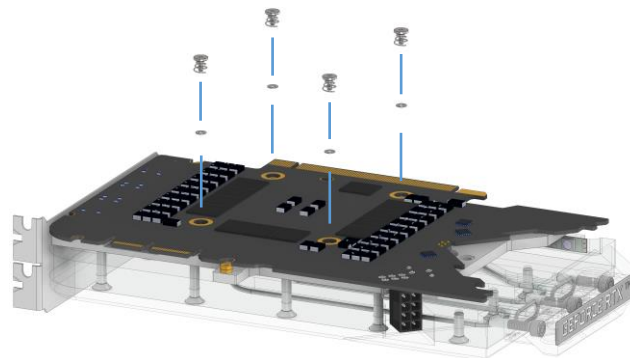

<p><b>EN</b> Place the graphics card on the prepared cooler. Fasten the card as shown with the 4 M2x5 screws with M2 washers. Hand-tighten the screws crosswise, one turn at a time.</p>	<p><b>DE</b> Legen Sie die Grafikkarte auf den vorbereiteten Kühler. Verschrauben Sie die Karte wie dargestellt mit den 4 M2x5 Schrauben und M2-Unterlegscheiben. Ziehen Sie die Schrauben kreuzweise, mit je einer Umdrehung, handfest an.</p>	<p><b>FR</b> Placez la carte graphique sur la glacière préparée. Vissez la carte comme indiqué avec les 4 vis M2x5 et les rondelles M2. Serrez les vis en croix, un tour à la fois, à la main.</p>
--	---	--

5.

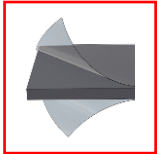
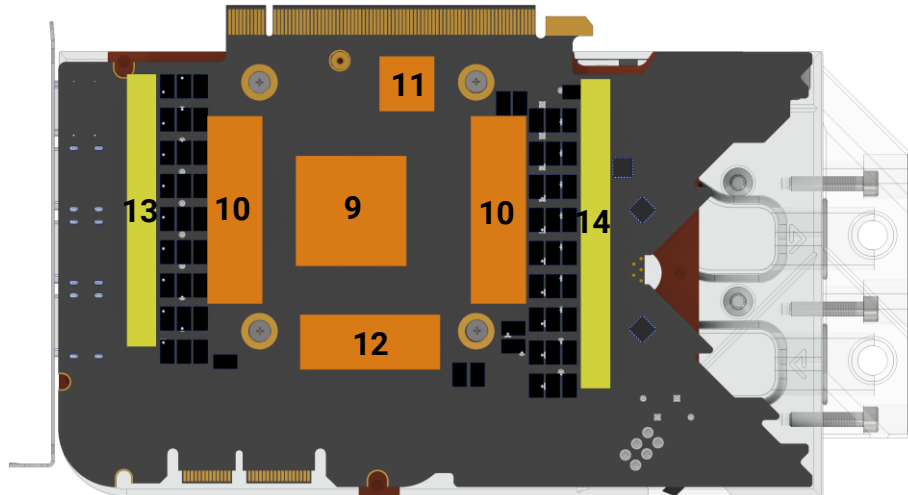

EN

Remove the protective foils from the thermal pads and place the pads on the PCB as shown.

DE

Entfernen Sie die Schutzfolien der Wärmeleitpads und platzieren Sie die Pads wie dargestellt auf der Platine.

FR

Retirez les feuilles de protection des pads thermiques et placez les pads sur la carte comme indiqué.

6.

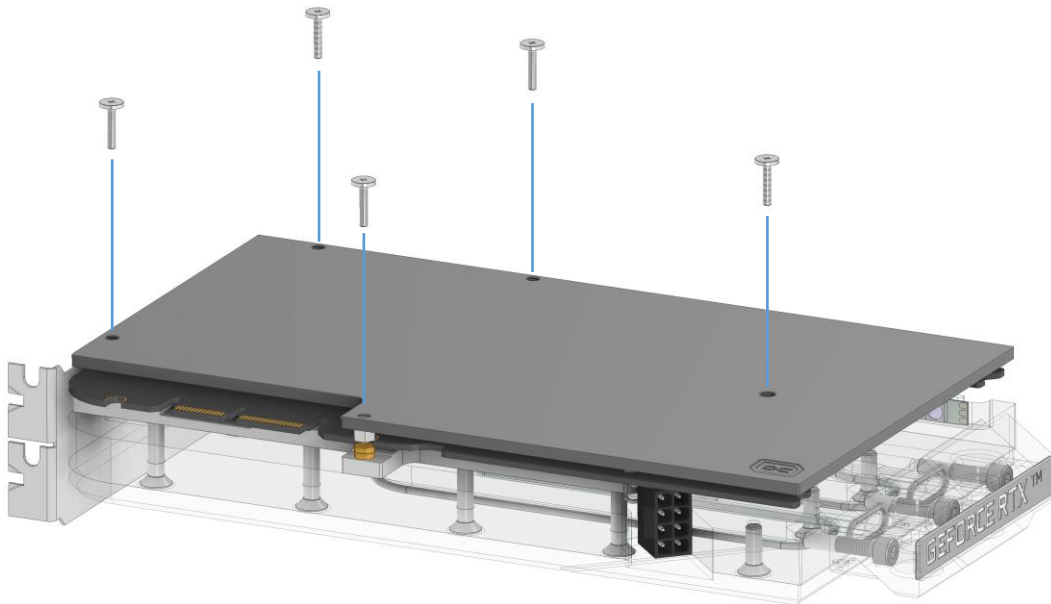

EN

Put the backplate on and screw it together with the 5 M2x11 screws as shown.

DE

Legen Sie nun die Backplate auf und verschrauben Sie diese mit den 5 M2x11 Schrauben wie dargestellt.

FR

Remettez maintenant la plaque arrière en place et vissez-la avec les 5 M2x11 comme indiqué sur l'illustration.

7.

Digital – RGB LEDs

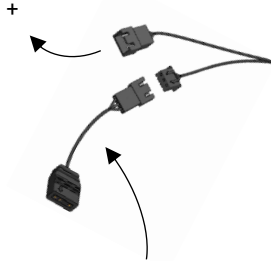

Digital – RGB Controller

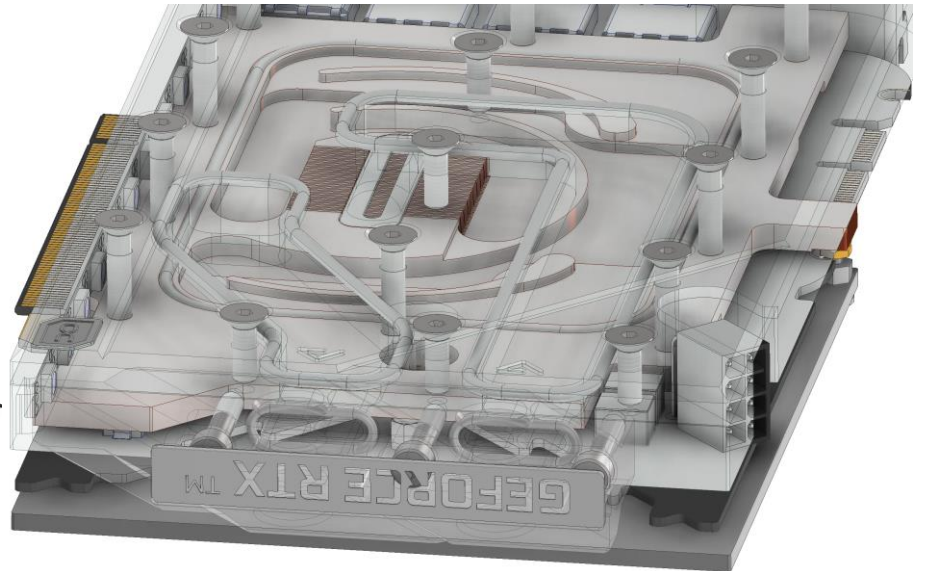

<p><b>EN</b> To control the digital - RGB lighting, connect the included adapter to the 3 - pin female connector and plug it to a digital - RGB controller (e.g. Alphacool Aurora Eiscontrol, Art.: 15360, not included). You can connect additional digital - RGB LEDs to the remaining 3 - pin male connector.</p>	<p><b>DE</b> Um die Digital - RGB Beleuchtung zu steuern, schließen Sie den beiliegenden Adapter an den 3-Pin female Stecker an und verbinden Sie diesen mit einem Digital - RGB Controller (z.B. Alphacool Aurora Eiscontrol, Art.: 15360, nicht im Lieferumfang enthalten). An den übrigen 3-Pin male Stecker können Sie zusätzliche Digital - RGB LEDs anschließen.</p>	<p><b>FR</b> Pour contrôler l'éclairage Digital - RGB, connectez l'adaptateur fourni au connecteur femelle 3 broches et branchez-le à un contrôleur Digital - RGB (par ex. Alphacool Aurora Eiscontrol, Art. 15360, non fourni). Vous pouvez connecter des LEDs Digital - RGB supplémentaires au connecteur mâle 3 broches restant.</p>
--	--	---

8.

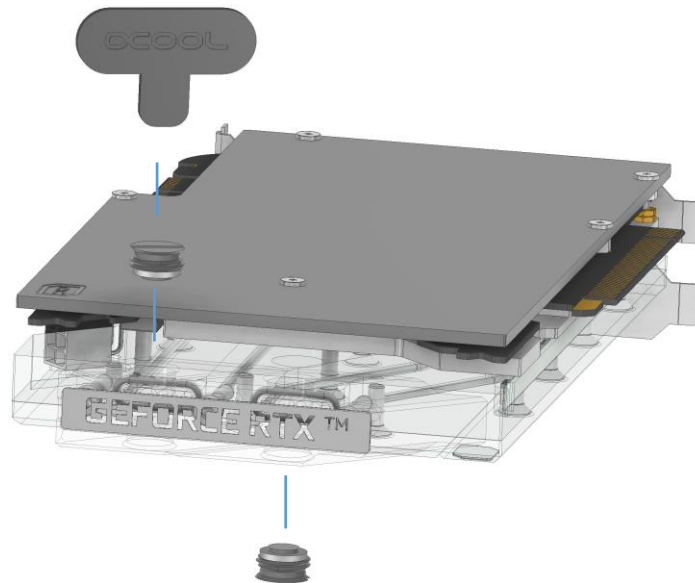

<p><b>EN</b> Close the inlets which you do not need for tubing. Screw in the screw plugs with the enclosed tool.</p>	<p><b>DE</b> Verschließen Sie alle Einlässe, die Sie nicht für die Anschlüsse benötigen. Drehen Sie die Verschlusschrauben mit dem beiliegenden Werkzeug ein.</p>	<p><b>FR</b> Fermez les entrées dont vous n'avez pas besoin pour les tuyaux. Vissez les bouchons à l'aide de l'outil fourni.</p>
--	---	--