











### Accessories

- |   |   |  |  |  |   |  |  |  |
|---|---|--|--|--|---|--|--|--|
| <b>A</b><br><br>4x<br>8x8x1mm<br>Pad | <b>B</b><br><br>2x<br>84x8x1mm<br>Pad | <b>C</b><br><br>1x<br>15x15x1mm<br>Pad | <b>D</b><br><br>2x<br>105x8x1mm<br>Pad | <b>E</b><br><br>2x<br>50x15x1mm<br>Pad | <b>F</b><br><br>1x<br>40x15x1mm<br>Pad | <b>G</b><br><br>1x<br>45x45x3mm<br>GPU-Pad | <b>H</b><br><br>5x<br>18x15x3mm<br>Pad | <b>I</b><br><br>1x<br>15x25x3mm<br>Pad |
| <b>J</b><br><br>5x<br>M2 washer     | <b>K</b><br><br>5x<br>M2x5 screw     | <b>L</b><br><br>1x<br>thermal grease  | <b>M</b><br><br>5x<br>M2x11 screws    | <b>N</b><br><br>1x<br>M2x5 screw      |   |  |  |  |

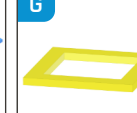
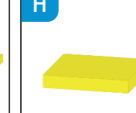
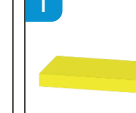
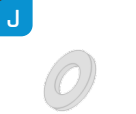
### Install thermal pads on cooling block

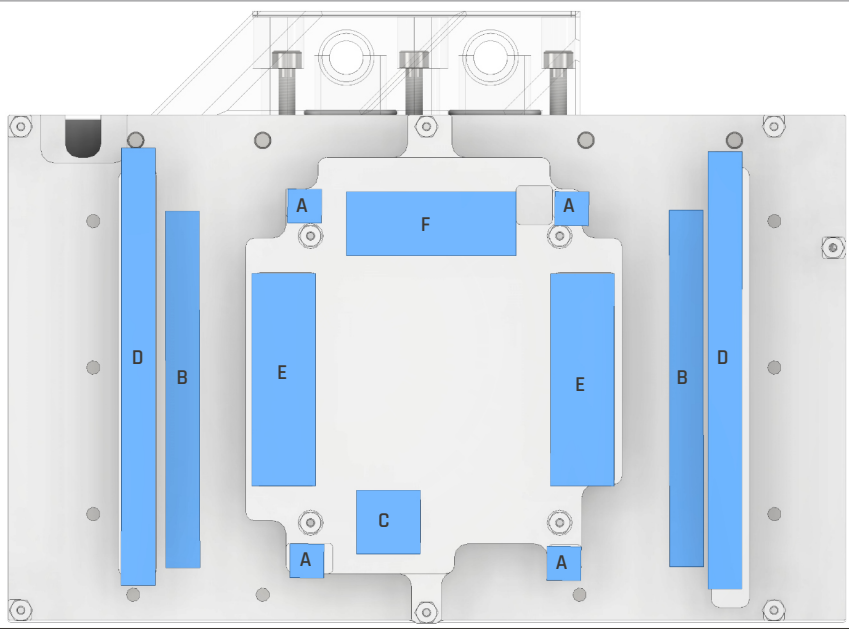

### Apply Thermal Grease

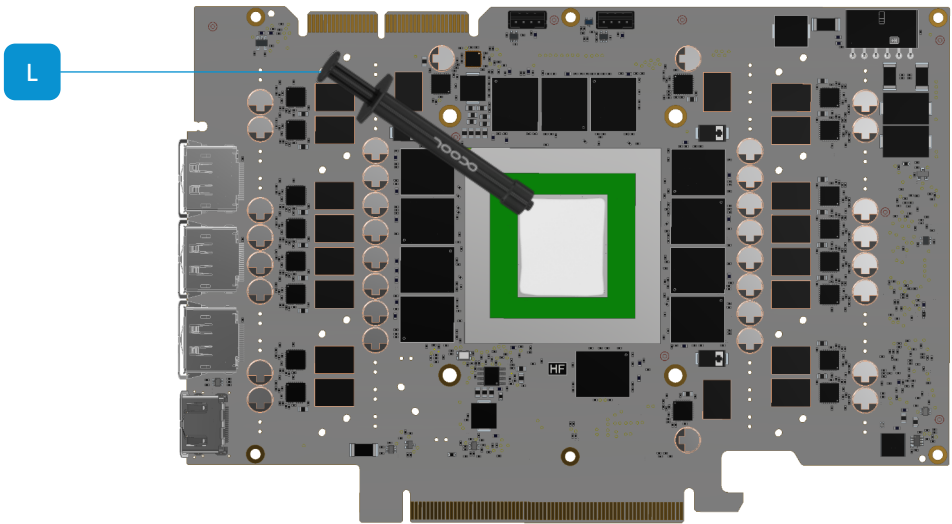

**Install PCB:** Lightly tighten the 4 M2X5 screws closest to the die with 4 washers clockwise, half a turn at a time, starting with screw 1 (see illustration). Repeat the procedure in the order shown until all screws are hand-tightened. Do NOT tighten the screws crosswise or deviate from the order shown in the image. Tighten screw 5 with the 5th washer the usual way.

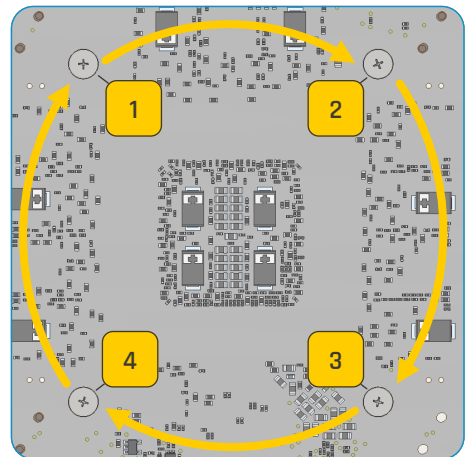
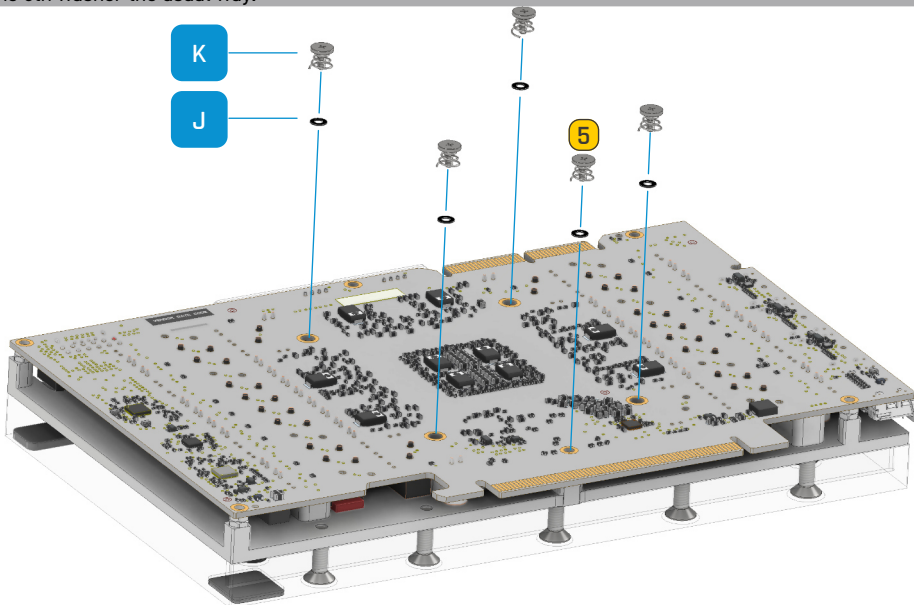

### Install thermal pads on PCB backside

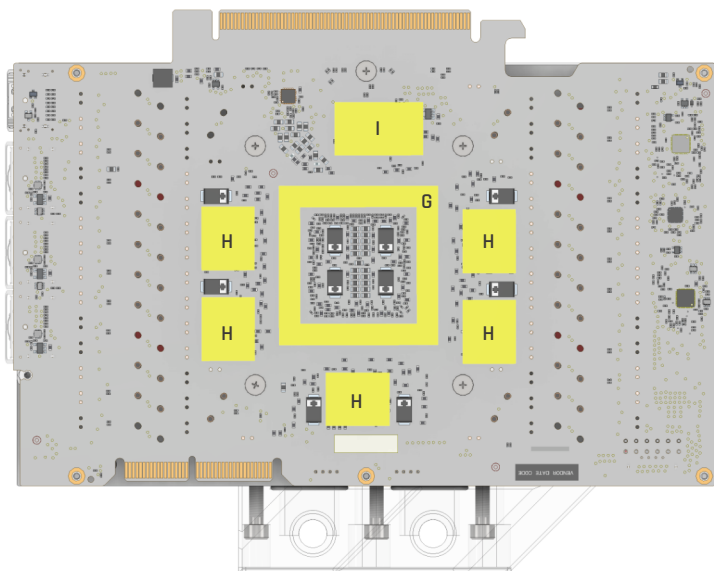

## Mount backplate

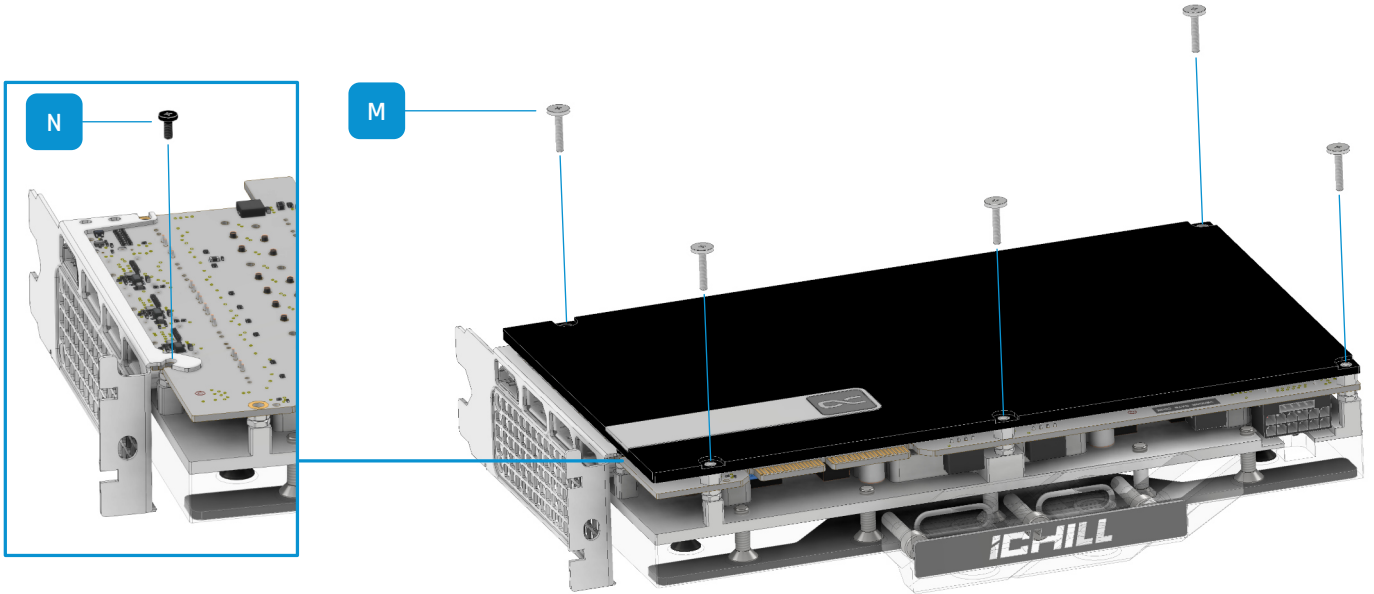

Need help?



Alphacool International GmbH  
Marienberger Str. 1  
D-38122 Braunschweig  
Germany

Support: +49 (0) 531 28874 - 0  
Fax: +49 (0) 531 28874 - 22  
E-mail: [info@alphacool.com](mailto:info@alphacool.com)  
<https://www.alphacool.com>

We care!