

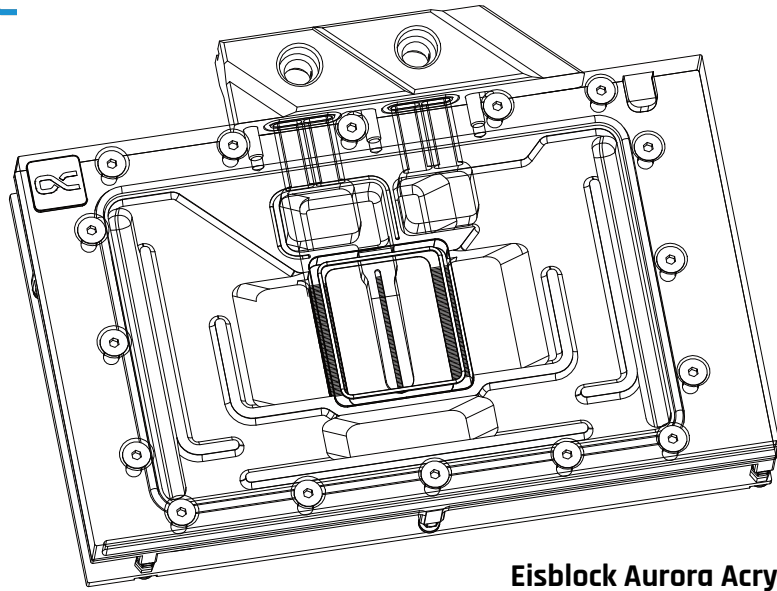

alphacool



Alphacool
Eisblock Aurora Acryl GPX-N RTX 4090 Reference
with Backplate



Safety instructions
Sicherheitshinweise
Avis de sécurité



Digital guide
Digitale Anleitung
Guide digital



EN

Accessories

DE

Zubehör

FR

Accessoires

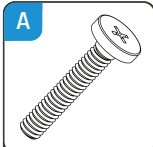

5x
M2x11mm
Screw

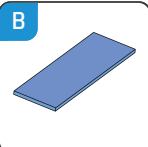

2x
51x15x1mm
Pad

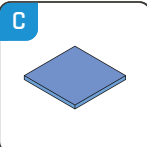

2x
8x8x1mm
Pad

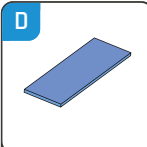

1x
40x15x1mm
Pad

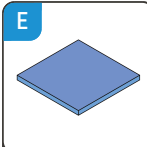

1x
15x15x1mm
Pad

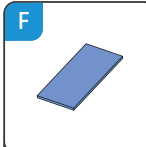

1x
15x8x1mm
Pad

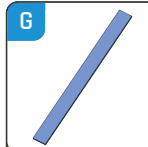

1x
100x8x1mm
Pad

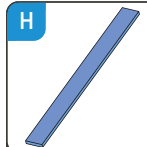

1x
105x8x1mm
Pad

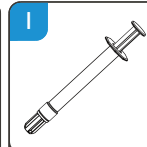

1x
Thermal Grease

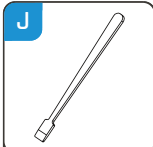

1x
Putty tool

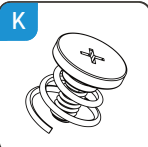

5x
M2x5mm
Screw

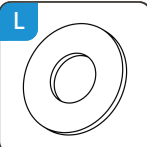

5x
EVA Washer

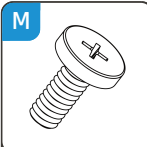

1x
M2x5mm
Screw

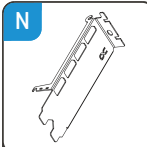

1x
PCI Bracket

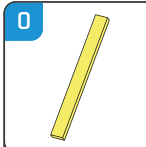

2x
85x8x3mm
Pad

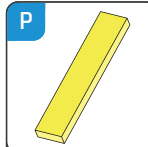

2x
51x8x3mm
Pad

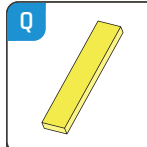

1x
40x8x3mm
Pad

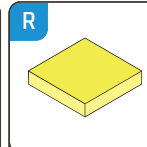

1x
15x15x3mm
Pad

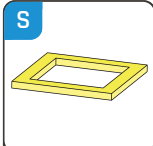

1x
45x45x3mm
GPU-Pad

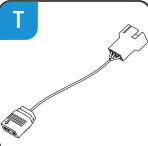

1x
ARGB
Adapter



2x
G1/4 Plug



1x
Plug tool

Before starting the cooler assembly, compare your card with the pictures in our configurator. To do so, visit www.hwconfig.com and search for your graphics card or cooler model. For a definitiv identification, you can also compare the PCB number. The cooler was designed for a special PCB layout. Occasionally, graphics card manufacturers may revise the design of their card slightly, causing the cooler not to fit on later models. During assembly, please make sure taller parts have enough space around them and that the cooler does not damage your graphics card.

Vor der Kühlermontage prüfen Sie bitte die Kompatibilität Ihrer Platine anhand unseres Konfigurators auf www.hwconfig.com. Vergleichen Sie auch die PCB-Nummer für klare Zuordnung. Beachten Sie, dass der Kühler speziell für ein bestimmtes PCB-Layout entwickelt wurde. Hersteller können Revisionen vornehmen, die zu Inkompatibilität mit späteren Modellen führen können. Achten Sie während der Montage darauf, dass hohe Bauteile frei bleiben und der Kühler keine Beschädigungen anrichtet.

Avant d'assembler le refroidisseur, vérifiez sa compatibilité avec votre carte graphique sur www.hwconfig.com. Comparez également les numéros de PCB pour une identification précise. Assurez-vous que le bloc de refroidissement n'endommage pas la carte graphique et que les composants plus hauts ne la touchent pas pendant l'installation. Soyez attentif à ces détails pour éviter tout problème lors de l'assemblage.

Alphacool International GmbH is not liable for assembly errors occurring due to negligence, such as selecting an incompatible cooler.

Alphacool International GmbH haftet nicht bei fahrlässigen Montagefehlern, wie die Wahl eines inkompatiblen Kühlers.

Alphacool International GmbH n'est pas responsable ni des erreurs d'installation ni du choix d'un refroidisseur incompatible.

Put the hardware on an antistatic mat. Begin dismantling the original cooler. Depending on the structure of the cooler, remove the screws at the back of the card and carefully unhook the fan connector first. If the original cooler uses thermal glue, extreme care should be taken as you can easily damage parts. Pick up all the items carefully. Next, clean the hardware of thermal paste or pad residues with a solvent (e.g. isopropanol alcohol).

Legen Sie die Hardware auf eine antistatische Unterlage. Beginnen Sie mit der Demontage des Original-Kühlers. Je nach Aufbau des Kühlers sind zuerst die Schrauben des Lüfters zu entfernen und die Blenden zu lösen. Bei aufgeklebten Kühlern ist äußerste Sorgfalt geboten. Es können leicht Bauteile abgerissen werden. Heben Sie alle Einzelteile sorgfältig auf. Reinigen Sie anschließend die Hardware von Resten der Wärmeleitpaste oder Pads mit einem Lösemittel (z.B. Isopropanol-Alkohol).

Posez le matériel sur un tapis antistatique. Commencez par le démontage du refroidisseur d'origine. Selon la configuration du radiateur les vis du ventilateur et les caches doivent être enlevés d'abord. S'il s'agit d'un refroidisseur collé il faut travailler très doucement. Sinon des composants peuvent s'arracher. Conservez tous les pièces soigneusement. Ensuite, nettoyez le matériel de résidus de la pâte thermique ou de pads avec un solvant (alcool isopropanol par ex.).

Only remove the plastic transport spacers

Nur die Transportabstandshalter aus Plastik entfernen

Retirer uniquement les entretoises de transport en plastique

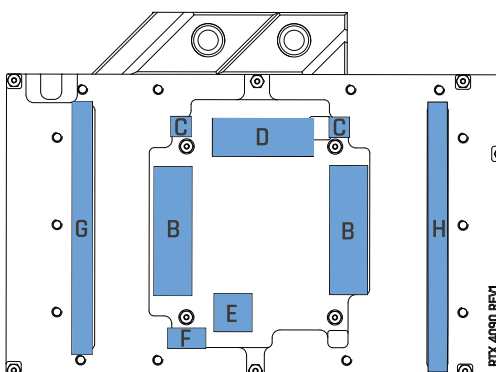
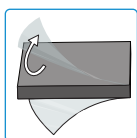
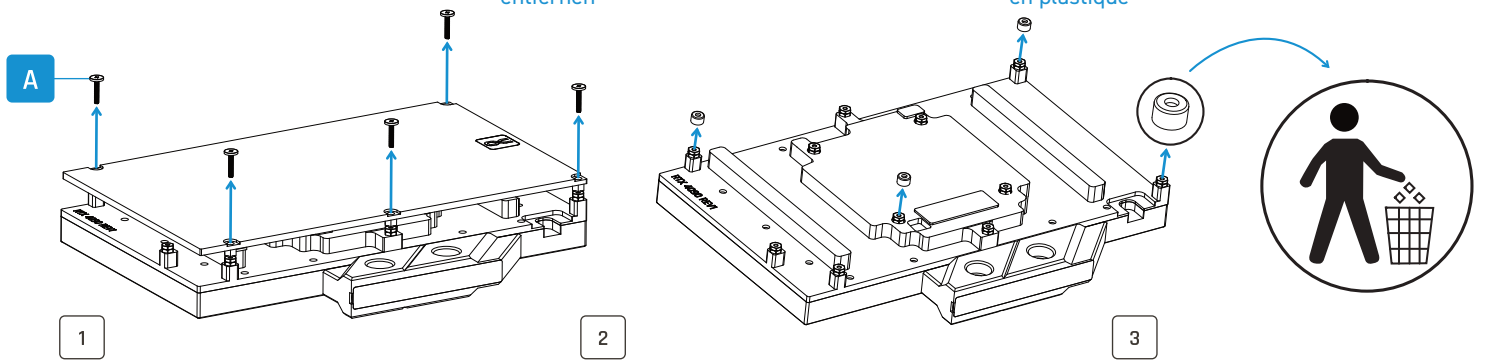

EN

Apply Thermal Grease

DE

Wärmeleitpaste auftragen

FR

Appliquer la pâte thermique

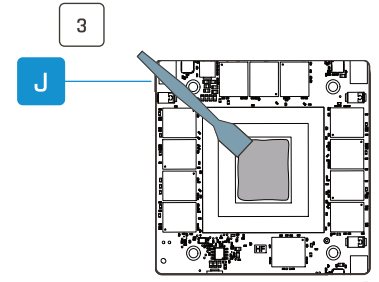
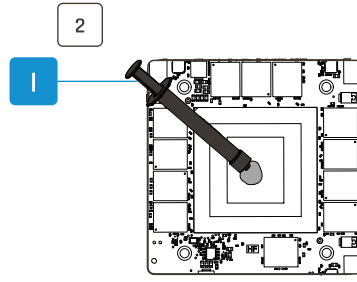
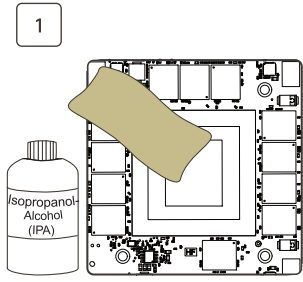

EN

Install PCB

DE

PCB installieren

FR

Installer PCB

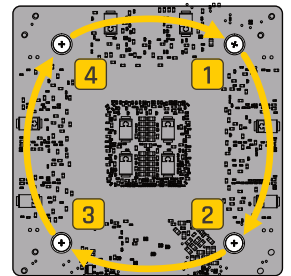
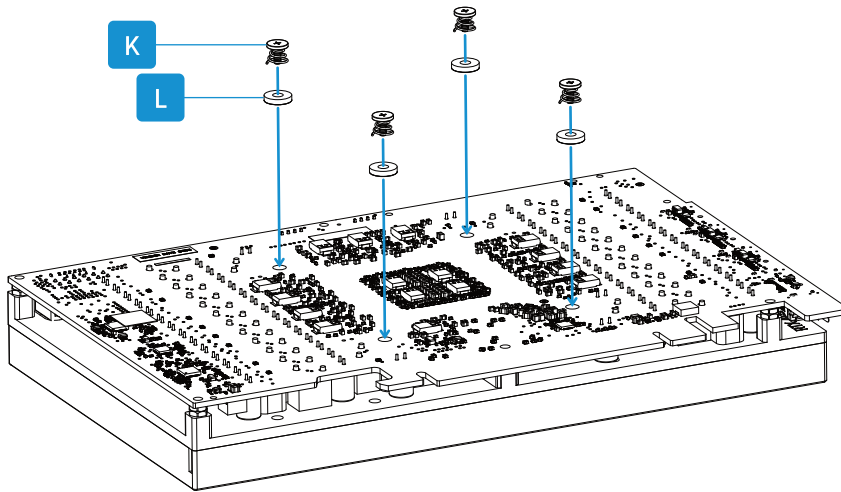
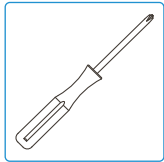

EN

Install PCB and PCI-Bracket

DE

PCB und PCI-Bracket installieren

FR

Installer le PCB et le support PCI

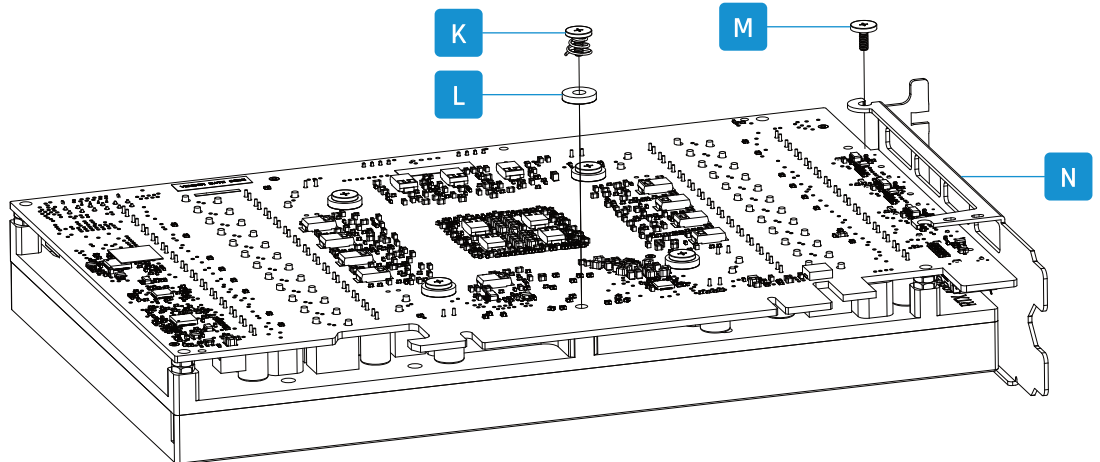
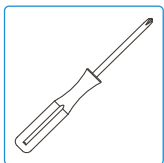

EN Place thermal pads on PCB backside

DE Wärmeleitpads auf die PCB Rückseite platzieren

FR Placer les pads thermique sur le PCB au dos

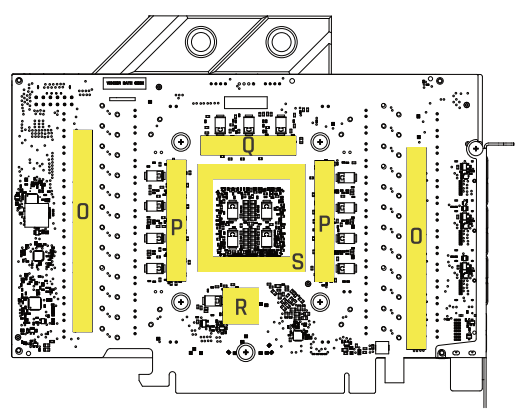

EN Mount backplate and screw in screw plugs with the tool

DE Backplate montieren und Verschlusschrauben eindrehen

FR Monter la plaque arrière et Visser les vis de fermeture avec l'outil

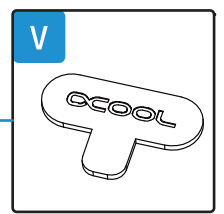
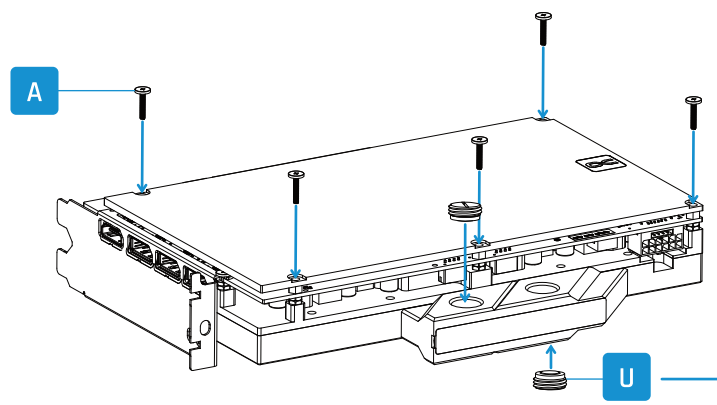
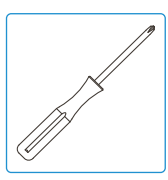

EN Connect ARGB lighting

DE ARGB Beleuchtung anschließen

FR Connecter l'éclairage ARGB

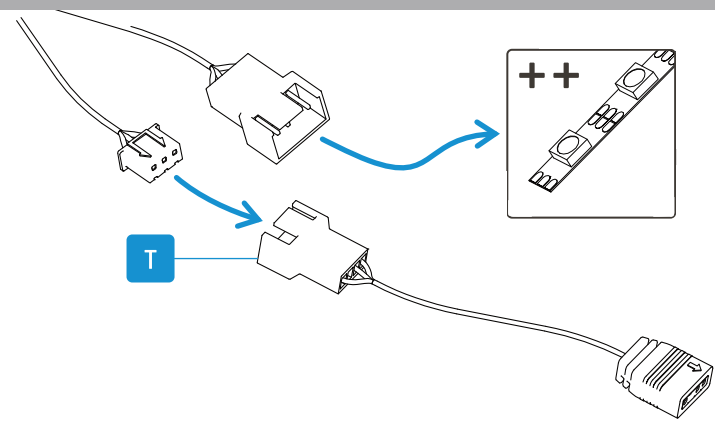

T

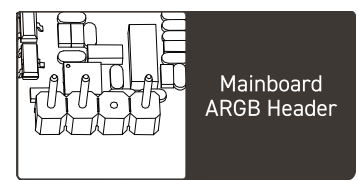
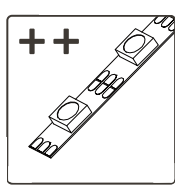

Mainboard ARGB Header



Aurora Eiscontrol Art. Nr.: 15360

Need help?



Alphacool International GmbH
Marienberger Str. 1
D-38122 Braunschweig
Germany

Support: +49 (0) 531 28874-0
Fax: +49 (0) 531 28874 - 22
E-Mail: info@alphacool.com
<https://www.alphacool.com>

We care!