

















ALPHACOOOL EISBLOCK AURORA ACETAL GPX-N QUADRO RTX A6000 INCL. BACKPLATE

- EN** Read the safety instructions before starting the installation.
- DE** Lesen Sie die Sicherheitshinweise, bevor Sie mit der Installation beginnen.
- FR** Lisez les instructions de sécurité avant de commencer l'installation.

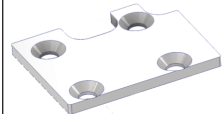

ACCESSORIES		ZUBEHÖR		ACCESSOIRES	
					
1x 15x15x1mm	1x 15x38x1mm	2x 15x51x1mm	1x 8x8x1mm	3x 8x84x1mm	1x 8x74x1mm
					
1x 15x38x2mm	2x 15x51x2mm	1x 15x15x2mm	3x 8x84x2mm	1x 8x74x2mm	1x 30x30x2mm
					
4x M2x5 screws	4x M2 washers	6x M2x11 screws	4x M3x8 screws	1x Thermal grease	1x Cover plate

COMPATIBILITY CHECK	KOMPATIBILITÄT PRÜFEN	VÉRIFICATION DE COMPATIBILITÉ
<p>Before starting the cooler assembly, compare your card with the pictures in our configurator. To do so, visit https://www.hwconfig.com and search for your graphics card or cooler model. For a definitive identification, you can also compare the PCB number. The cooler was designed for a special PCB layout. Occasionally, graphics card manufacturers may revise the design of their card slightly, causing the cooler not to fit on later models. During assembly, please make sure taller parts have enough space around them and that the cooler does not damage your graphics card.</p> <p>Alphacool International GmbH is not liable for assembly errors occurring due to negligence, such as selecting an incompatible cooler.</p>	<p>Bevor Sie mit der Montage des Kühlers beginnen, vergleichen Sie Ihre Platine mit den Fotos in unserem Konfigurator. Besuchen Sie dafür https://www.hwconfig.com und suchen Sie nach Ihrem Grafikkarten- oder Kühlermodell. Zur eindeutigen Zuordnung kann dort auch die PCB Nummer verglichen werden. Der Kühler wurde für ein spezielles PCB Layout konstruiert. Es kommt vor, dass Grafikkartenhersteller über Revisionen den Aufbau leicht abändern und der Kühler auf spätere Modelle nicht mehr passt. Achten Sie auch bei der Montage darauf, dass hohe Bauteile frei liegen und der Kühler die Grafikkarte nicht beschädigt.</p> <p>Alphacool International GmbH haftet nicht bei fahrlässigen Montagefehlern, wie die Wahl eines inkompatiblen Kühlers.</p>	<p>Avant de commencer l'assemblage du refroidisseur, comparez votre carte avec les images de notre configurateur. Pour ce faire, visitez https://www.hwconfig.com et cherchez votre carte graphique ou votre modèle de refroidisseur. Pour une identification précise, vous pouvez également comparer le numéro de la PCB. Le refroidisseur a été conçu pour une disposition spéciale du PCB. Il est possible que le fabricant change des détails dans la disposition de ses composants lors d'une révision et que le bloc de refroidissement ne soit plus compatible. Veillez lors de l'installation au fait que les composants hauts ne touchent pas le bloc de refroidissement et que le bloc n'endommage pas la carte graphique.</p> <p>Alphacool International GmbH n'est pas responsable ni des erreurs d'installation ni du choix d'un refroidisseur incompatible.</p>

PREPARE GRAPHICS CARD	GRAFIKKARTE VORBEREITEN	PRÉPARER LA CARTE GRAPHIQUE
<p>Put the hardware on an antistatic mat. Begin dismantling the original cooler. Depending on the structure of the cooler, remove the screws at the back of the card and carefully unhook the fan connector first. If the original cooler uses thermal glue, extreme care should be taken as you can easily damage parts. Pick up all the items carefully. Next, clean the hardware of thermal paste or pad residues with a solvent (e.g. isopropanol alcohol).</p>	<p>Legen Sie die Hardware auf eine antistatische Unterlage. Beginnen Sie mit der Demontage des Original-Kühlers. Je nach Aufbau des Kühlers sind zuerst die Schrauben des Lüfters zu entfernen und die Blenden zu lösen. Bei aufgeklebten Kühlern ist äußerste Sorgfalt geboten. Es können leicht Bauteile abgerissen werden. Heben Sie alle Einzelteile sorgfältig auf. Reinigen Sie anschließend die Hardware von Resten der Wärmeleitpaste oder Pads mit einem Lösemittel (z.B. Isopropanol-Alkohol).</p>	<p>Posez le matériel sur un tapis antistatique. Commencez par le démontage du radiateur d'origine. Selon la configuration du radiateur les vis du ventilateur et les caches doivent être enlevés d'abord. S'il s'agit d'un refroidisseur collé il faut travailler très doucement. Sinon des composants peuvent s'arracher. Conservez tous les pièces soigneusement. Entretien, nettoyez le matériel de résidus de la pâte thermique ou de pads avec un solvant (alcool isopropanol par ex.).</p>

1.

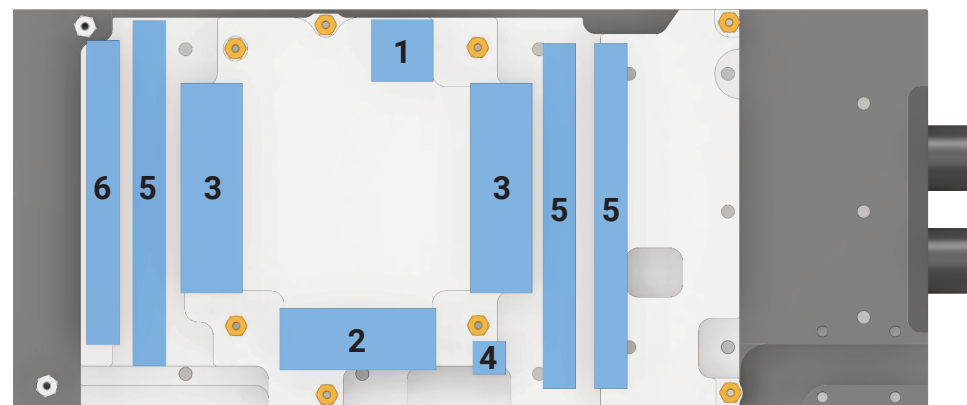

EN	DE	FR
Clean the contact surfaces on the bottom side of the cooler with alcohol or similar. The surface must be free of contaminants. Remove the protective foils from the thermal pads and place the pads on the copper block as shown.	Reinigen Sie die Kontaktflächen auf der Bodenseite des Kühlers mit Spiritus oder ähnlichen Mitteln. Die Fläche muss frei von Verunreinigungen sein. Entfernen Sie die Schutzfolien der Wärmeleitpads und platzieren Sie die Pads wie dargestellt auf dem Kupferblock.	Nettoyez les surfaces de contact (la face inférieure du bloc de refroidissement) avec de l'alcool. La surface doit être propre sans aucune pollution. Retirez les feuilles de protection des pads thermiques et placez les pads sur le bloc de cuivre comme indiqué.

2.

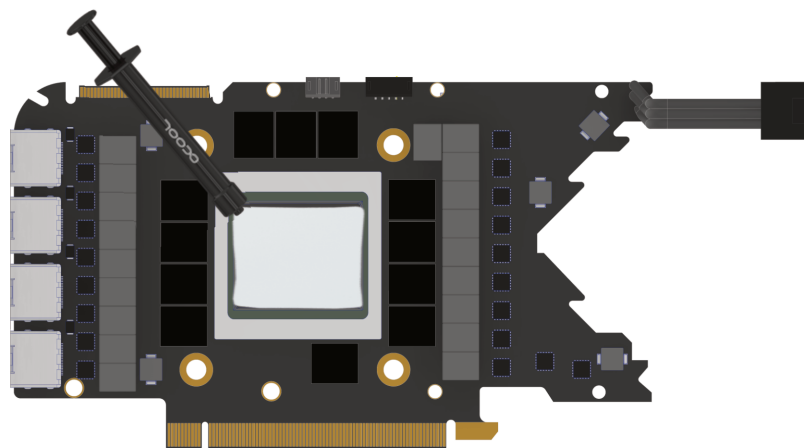

EN	DE	FR
With the help of a plastic strip or similar spread a thin layer of thermal paste on the GPU. The layer should be less than a millimeter thick, otherwise the surrounding components may be contaminated.	Tragen Sie nun eine gleichmäßige Schicht Wärmeleitpaste auf die GPU auf. Die Schicht sollte weniger als einen Millimeter dick sein, da die umliegenden Bauteile ansonsten verunreinigt werden können.	Appliquez maintenant la pâte thermique sur le processeur graphique à refroidir. Afin d'éviter de salir les composants autour la couche doit rester inférieure à un millimètre d'épaisseur.

3.

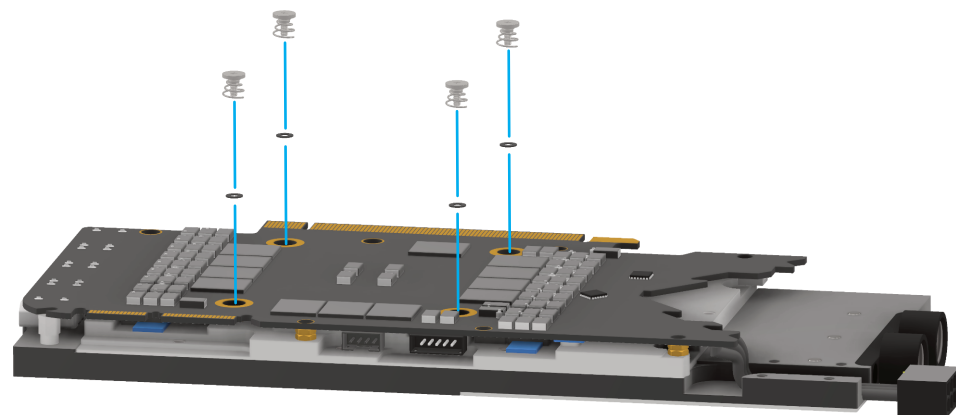

EN	DE	FR
Place the graphics card on the prepared cooler. Fasten the card as shown with the 4 M2x5 screws with M2 washers. Hand-tighten the screws crosswise, one turn at a time.	Legen Sie die Grafikkarte auf den vorbereiteten Kühler. Verschrauben Sie die Karte wie dargestellt mit den 4 M2x5 Schrauben und M2-Unterlegscheiben. Ziehen Sie die Schrauben kreuzweise, mit je einer Umdrehung, handfest an.	Placez la carte graphique sur la glacière préparée. Vissez la carte comme indiqué avec les 4 vis M2x5 et les rondelles M2. Serrez les vis en croix, un tour à la fois, à la main.

4.

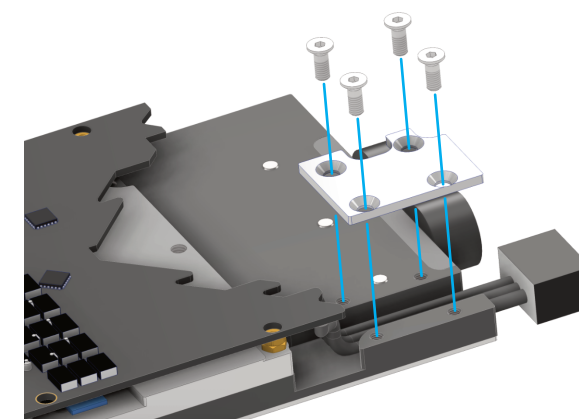

EN	DE	FR
Insert the power cable into the channel as shown. Put the cover plate on and screw it together with the 4 M3x8 screws as shown.	Legen Sie das Stromkabel in den dafür vorgesehenen Kanal. Legen Sie nun die Verschlussplatte auf und verschrauben Sie diese mit den 4 M3x8 Schrauben wie dargestellt.	Placez le câble d'alimentation dans le canal prévu à cet effet. Placez maintenant la plaque de recouvrement et vissez-la en place avec les 4 vis M3x8 comme indiqué.

5.

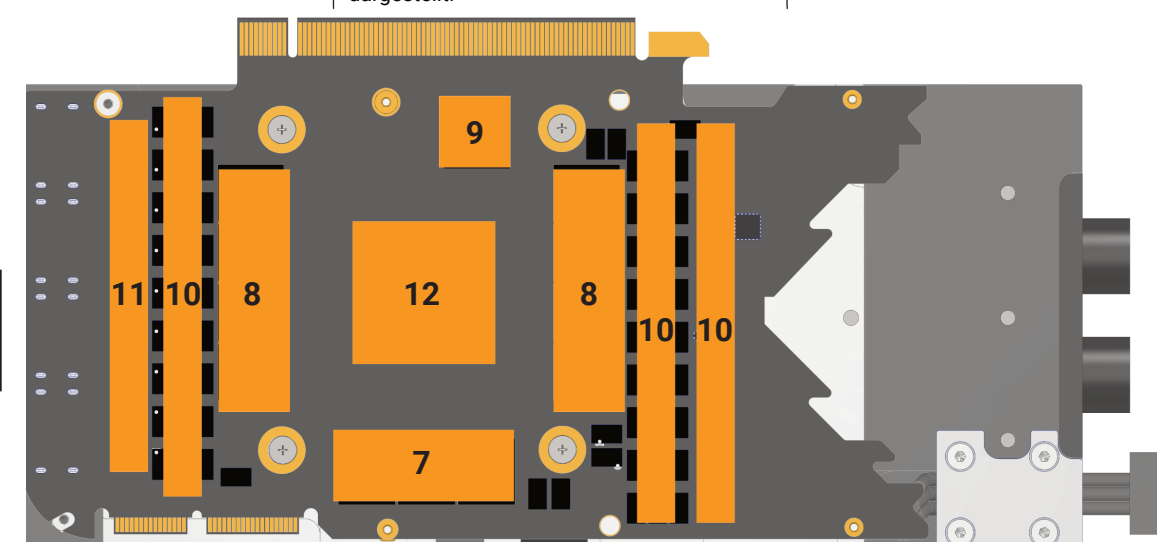

EN	DE	FR
Remove the protective foils from the thermal pads and place the pads on the PCB as shown.	Entfernen Sie die Schutzfolien der Wärmeleitpads und platzieren Sie die Pads wie dargestellt auf der Platine.	Retirez les feuilles de protection des pads thermiques et placez les pads sur la carte comme indiqué.

6.

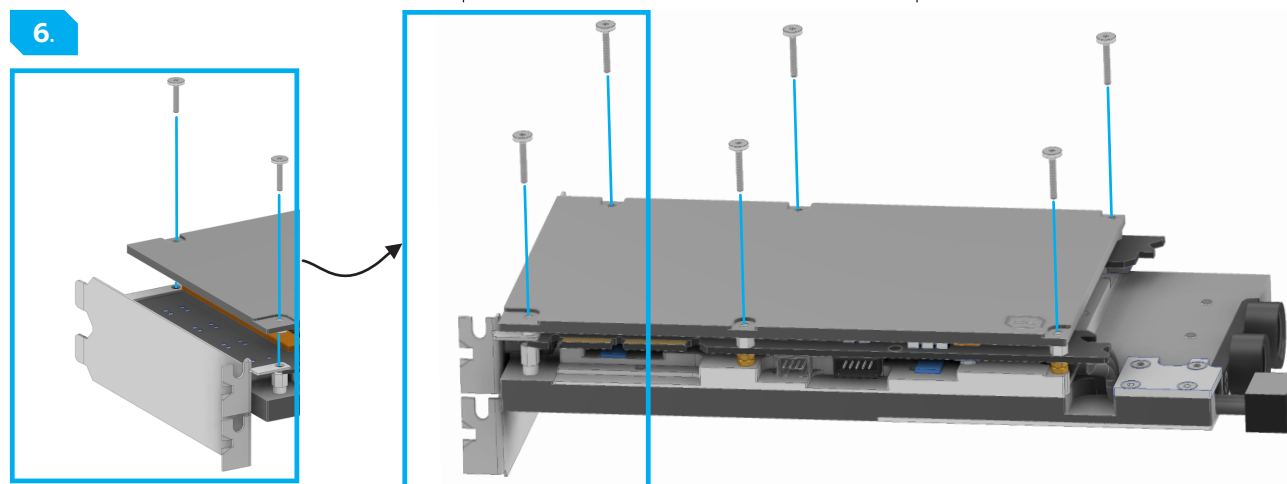

EN	DE	FR
Put the backplate on and screw it together with the 6 M2x11 screws as shown.	Legen Sie nun die Backplate auf und verschrauben Sie diese mit den 6 M2x11 Schrauben wie dargestellt.	Remettez maintenant la plaque arrière en place et vissez-la avec les 6 vis M2x11 comme indiqué sur l'illustration.



ALPHACOOL – THE COOLING COMPANY

Alphacool International GmbH
Marienberger Str. 1
D-38122 Braunschweig

Support: +49 (0) 531 28874 - 0
Fax: +49 (0) 531 28874 - 22
E-Mail: info@alphacool.com

General Managers: Andreas Rudnicki, Nathanael Draht, Fabian Noelte
WEEE-Reg.-Nr.: DE 544444
Trade Register: Amtsgericht Braunschweig HRB 202390
VAT.ID.Nr.: DE27058421
Tax number: 13/207/02047